

SCDS Series

Shielded SMD
Power Inductors

APPLICATIONS

- Power Supply for VTRs
- OA Equipment
- LCD Televisions
- Notebook PCs
- Portable Communication Equipment
- DC / DC Converters, etc.

FEATURES

- Available in Magnetically Dhiided
- Low DC Resistance
- Suitable for Large Currents
- Ideal for a Variety of DC - DC Converter Inductor Applications
- Available on Tape and Reel for Auto Surface Mounting

SHAPES AND DIMENSIONS

Dimensions : mm

SCDS2D11/2D14
/2D18LD/2D18HP

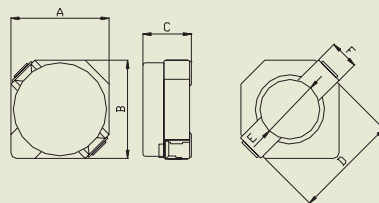

Dimensions in mm

TYPE	A	B	C	D	E	F
SCDS2D11	3.2 ⁺⁰	3.2 ⁺⁰	1.2 ⁺⁰	3.3	2.1	1.0
SCDS2D14	3.2 ⁺⁰	3.2 ⁺⁰	1.55 ⁺⁰	3.3	2.1	1.0
SCDS2D18LD	3.2 ⁺⁰	3.2 ⁺⁰	2.0 ⁺⁰	3.3	2.1	1.0
SCDS2D18HP	3±0.3	3±0.3	2.0 ⁺⁰	3.3	2.1	1.0

PRODUCT IDENTIFICATION

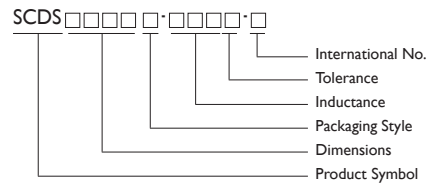

- T : Packing : Tape and Reel
- HP : Low DCR
- LD : High Power
- Tolerance : K=±10% M=±20% T=±30%
- Internal No.: B: Silver plated terminals (3D12~6D38); S: Base type terminals (2D11~2D18HP & 62T&127)
- Note : YAGEO will start to release lead-free terminals that meet SONY SS-00259's criterial and YAGEO Internal No will changed to "N" as identification.

RECOMMENDED PATTERN

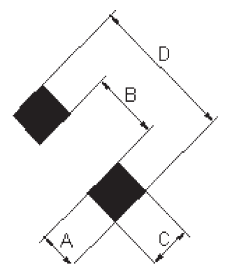

Dimensions in mm

TYPE	A	B	C	D
SCDS2D11	1.3	1.7	1.3	4.3
SCDS2D14	1.3	1.7	1.3	4.3
SCDS2D18LD	1.3	1.7	1.3	4.3
SCDS2D18HP	1.3	1.7	1.3	4.3



SHAPES AND DIMENSIONS

RECOMMENDED PATTERN

SCDS 3D12

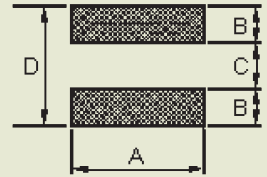
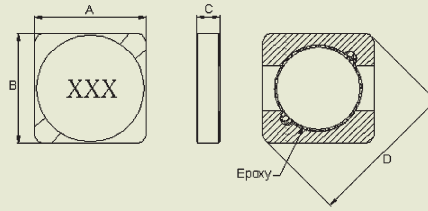

Dimensions in mm

TYPE	A	B	C	D
SCDS3D12	3.9 ± 0.2	3.9 ± 0.2	1.2 Max	6.2 Max

Dimensions in mm

TYPE	A	B	C	D
SCDS3D12	4.6	1.6	1.4	4.6

SCDS 3D16

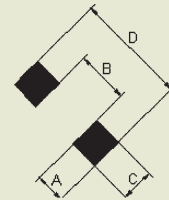
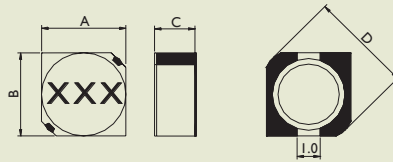

Dimensions in mm

TAPE	A	B	C	D
SCDS3D16	4 Max.	4 Max.	1.8 Max.	5.2 Max.

Dimensions in mm

TYPE	A	B	C	D
SCDS3D16	1.4	2.4	1.5	5.2

SCDS 4D18~6D38

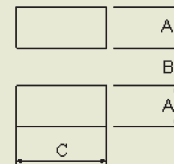
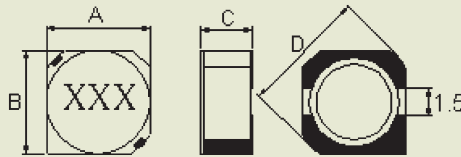

Dimensions in mm

TAPE	A	B	C	D
SCDS4D18	4.7 ± 0.3	4.7 ± 0.3	2.0 Max	6.9 Max
SCDS4D28	4.7 ± 0.3	4.7 ± 0.3	3.0 Max	6.9 Max

Dimensions in mm

TYPE	A	B	C
SCDS 4D18	1.9	1.5	5.3
SCDS 4D28	1.9	1.5	5.3

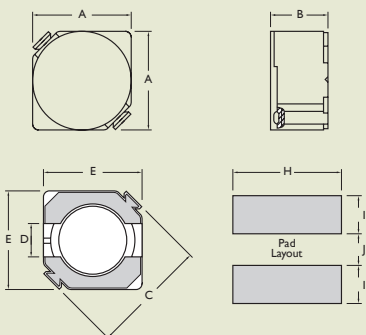

ITEM	A	B	C	D	E	H	I	J
5D18	5.7 ± 0.3	2.0 Max.	8.2 Max.	1.5	5.7±0.3	6.3	2.15	2.0
5D28	5.7 ± 0.3	3.0 Max.	8.2 Max.	1.5	5.7±0.3	6.3	2.15	2.0
6D28	6.7 ± 0.3	3.0 Max.	9.5 Max.	1.5	6.7±0.3	7.3	2.65	2.0
6D38	7.0 ± 0.0	4.0 Max.	9.5 Max.	1.5	7.0±0.0	7.3	2.65	2.0



ELECTRICAL CHARACTERISTICS

Standard Specifications

Stamp	Inductance (H)	D.C.R.(mΩ)Max.												RatedCurrent(A)Max.												
		SCDS 2D11	SCDS 2D14	SCDS 2D18LD	SCDS 2D18HP	SCDS 3D12	SCDS 3D16	SCDS 4D18	SCDS 4D28	SCDS 5D18	SCDS 5D28	SCDS 6D28	SCDS 6D38	SCDS 2D11	SCDS 2D14	SCDS 2D18LD	SCDS 2D18HP	SCDS 3D12	SCDS 3D16	SCDS 4D18	SCDS 4D28	SCDS 5D18	SCDS 5D28	SCDS 6D28	SCDS 6D38	
R47			40												2											
1R0	1.0					40.1±30%		45										1.54		1.72						
1R2	1.2								23.6													2.56				
1R5	1.5	68	63			63.5±30%	52						0.90	1.80			1.32	1.55								
1R7					44											1.85										
1R8	1.8		75						27.5						1.65							2.20				
2R2	2.2	98	94	41	60	83.5±30%	72	75	31.3				0.78	1.50	0.85	1.6	1.12	1.20	1.32	2.04						
2R4	2.4																									
2R5	2.5									18													2.60			
2R7	2.7		106					105	43.3	52				1.35					1.28	1.60	2.1					
3R0	3.0										24	24										2.40	3.00			
3R3	3.3	123	125	54	86	122±30%	85	110	49.2				0.60	1.20	0.75	1.45	0.90	1.10	1.04	1.57				3.50		
3R5	3.5																									
3R8	3.8																									
3R9	3.9	160	138					155	64.8				0.60	1.10				0.88	1.44				2.60			
4R1	4.1									57												1.95				
4R2	4.2										31												2.20			
4R7	4.7	170	169	78	140	172±30%	105	162	72.0		38	31	22	0.50	1.00	0.63	1.2	0.72	0.90	0.84	1.32		1.90	2.40	3.10	
5R0	5.0											31	24											2.40	2.90	
5R2	5.2																									
5R3	5.3										38												1.90			
5R4	5.4									76												1.60				
5R5	5.5																									
5R6	5.6		188			191±30%		170	100.9				0.95				0.66		0.80	1.17				2.25		
6R0	6.0												35											2.25		
6R1	6.1																									
6R2	6.2									96	45		27									1.40	1.80		2.50	
6R3				160												1.05										
6R8	6.8	260	213	106		218±30%	170	200	108.9	100	50	52	29	0.44	0.85	0.52		0.60	0.73	0.76	1.12	1.55	1.65	2.10	2.40	
7R0	7.0																									
7R3	7.3											54												2.10		
7R4	7.4												31												2.30	
7R6	7.6																									
8R2	8.2		281			255±30%		245	117.5		53			0.80				0.57		0.68	1.04		1.60			
8R6	8.6												58											1.85		
8R7	8.7												34												2.20	
8R9	8.9									116												1.25				
100	10	400	294	180	245	4083±0%	210	280	128.3	124	65	65	38	0.35	0.70	0.43	0.85	0.49	0.55	0.61	1.00	1.20	1.30	1.70	2.00	
120	12		394			462±30%		320	131.6	153	76	70	53		0.62			0.47		0.56	0.84	1.10	1.20	1.55	1.70	
150	15			220	345	502±30%	295	360	149.0	196	103	84	57			0.35	0.7	0.41	0.45	0.50	0.76	0.97	1.10	1.40	1.60	
180	18					573±30%		400	166.0	210	110	95	92					0.37		0.48	0.75	0.85	1.00	1.32	1.50	
220	22	950		320		801±30%	430	480	235.0	290	122	128	96	0.16		0.30		0.34	0.40	0.41	0.70	0.80	0.90	1.20	1.30	
270	27					1207±30%	620	570	261.0	330	175	142	109					0.30	0.62	0.35	0.58	0.75	0.85	1.05	1.20	
330	33			460		1358±30%	675	694	331.3	386	189	165	124			0.24		0.28	0.32	0.32	0.56	0.65	0.75	0.97	1.10	
390	39					1911±30%		800	383.7	520	212	210	138				0.23		0.30	0.50	0.57	0.70	0.86	1.00		
470	47			660			1240	950	587.0	595	250	238	150			0.20			0.28	0.48	0.54	0.62	0.80	0.95		
560	56							1080	624.5	665	305	277	202						0.26	0.41	0.50	0.58	0.73	0.85		
680	68							1300	699.0	840	355	304	234						0.24	0.35	0.43	0.52	0.65	0.75		
820	82								914.8	978	463	390	324							0.32	0.41	0.46	0.60	0.70		
101	100								1020	1200	520	535	358								0.29	0.36	0.42	0.54	0.65	
121	120								1270	1600											0.27	0.32				
151	150								1350	1800											0.24	0.30				
181	180								1540												0.22					
221	220																									
271	270																									
331	330																									
391	390																									
471	470																									

* Test Freq.(L): SCDS3D12/3D16:(100KHz/0.1V)
 SCDS4D18: 1.0 ~ 8.2H(7.96MHz/1V), 10 ~ 39H(100KHz/1V)
 SCDS2D11/2D14/2D18LD/4D28/104R/124:(100KHz/1V)
 SCDS5D18/5D28/6D28:(10KHz/1V)
 SCDS6D38:(10KHz/0.1V)
 SCDS62: 3.3 ~ 8.2H(7.96MHz/1V), 10~82H(2.52MHz/1V), 100 ~ 330H(1KHz/1V)
 • SCDS3D12 Rated current : It makes rated current either when the value with 30% declining inductance or the generation of heat becomes 30% near value by the rising one above another of the indirect current.
 • Other type Rated current : The rate current indicates the current when the inductance decreases to 65%. Over of it's nominal value or D.C.current when the temperature rising Dt =40°C lower, whichever is lower.
 • Test Instrument : L : HP4192A LF IMPEDANCE ANALYZER
 RDC : CHEN HWA 502BC
 Rated current: HP4284+42841A or Ch1061+CH301A

Tolerance Of Inductors
 • SCDS2D11 1.5~10H 30%(T)
 • SCDS2D14 1.5~12H 30%(T)* SCDS2D18LD 2.2~4.7H 30%(T)
 • SCDS3D12 1.0~39H 30%(T)
 • SCDS3D16 1.5~33H 30%(T)
 • SCDS4D18 1.0~68H 30%(T)
 • SCDS4D28 1.2~180H 30%(T)
 • SCDS5D18 4.1~100H 30%(T)
 • SCDS5D28 2.5~100H 30%(T)
 • SCDS6D28 3.0~100H 30%(T)
 • SCDS6D38 3.3~100H 30%(T)



ELECTRICAL CHARACTERISTICS : LEAD-FREE & ROHS COMPLIANCE

TYPE	Inductance(μ H)	Test Freq	RDC(Ω)	Rated Current(A)Max	I _{rms} (A)Typ	Tolerance
SCDS2D11T-1R5 □ -N	1.5	100KHz, 1V	0.068+0	0.9	1.48	T
SCDS2D11T-2R2 □ -N	2.2	100KHz, 1V	0.098+0	0.78	1.27	T
SCDS2D11T-3R3 □ -N	3.3	100KHz, 1V	0.123+0	0.6	1.02	T
SCDS2D11T-3R9 □ -N	3.9	100KHz, 1V	0.160+0	0.6	-	T
SCDS2D11T-4R7 □ -N	4.7	100KHz, 1V	0.170+0	0.5	0.88	T
SCDS2D11T-6R8 □ -N	6.8	100KHz, 1V	0.260+0	0.44	0.8	T
SCDS2D11T-100 □ -N	10	100KHz, 1V	0.400+0	0.35	0.65	M,T
SCDS2D11T-220 □ -N	22	100KHz, 1V	0.950+0	0.16	-	M,T

NOTE : □ -tolerance M=±20% / T=±30%

1. Operating temperature range -40°C~85°C(Includes temperature when the coil is heated)

2. Rate current: Inductance drop = 35% typ.

3. I_{rms}: Δ t=40°C

"-N" FOR COMPLETELY LEAD FREE TYPE(INCLUDING FERRITE BODY & SOLDER)

ELECTRICAL CHARACTERISTICS : LEAD-FREE & ROHS COMPLIANCE

TYPE	Inductance(μ H)	Test Freq	RDC(Ω)	Rated Current(A)Max	I _{rms} (A)Typ	Tolerance
SCDS2D14T-R47 □ -N	0.47	100KHz, 1V	0.040+0	2	-	T
SCDS2D14T-1R5 □ -N	1.5	100KHz, 1V	0.063+0	1.8	2	T
SCDS2D14T-1R8 □ -N	1.8	100KHz, 1V	0.075+0	1.65	1.8	T
SCDS2D14T-2R2 □ -N	2.2	100KHz, 1V	0.094+0	1.5	1.6	T
SCDS2D14T-2R7 □ -N	2.7	100KHz, 1V	0.106+0	1.35	1.4	T
SCDS2D14T-3R3 □ -N	3.3	100KHz, 1V	0.125+0	1.2	1.24	T
SCDS2D14T-3R9 □ -N	3.9	100KHz, 1V	0.138+0	1.1	1.12	T
SCDS2D14T-4R7 □ -N	4.7	100KHz, 1V	0.169+0	1	1	M,T
SCDS2D14T-5R6 □ -N	5.6	100KHz, 1V	0.188+0	0.95	0.98	M,T
SCDS2D14T-6R8 □ -N	6.8	100KHz, 1V	0.213+0	0.85	0.92	M,T
SCDS2D14T-8R2 □ -N	8.2	100KHz, 1V	0.281+0	0.8	0.8	M,T
SCDS2D14T-100 □ -N	10	100KHz, 1V	0.294+0	0.7	0.76	M,T
SCDS2D14T-120 □ -N	12	100KHz, 1V	0.394+0	0.62	0.64	M,T

NOTE : □ -tolerance M=±20% / T=±30%

1. Operating temperature range -40°C~85°C(Includes temperature when the coil is heated)

2. Rate current: Inductance drop = 35% typ.

3. I_{rms}: Δ t=40°C

"-N" FOR COMPLETELY LEAD FREE TYPE(INCLUDING FERRITE BODY & SOLDER)



ELECTRICAL CHARACTERISTICS : LEAD-FREE & ROHS COMPLIANCE

TYPE	Inductance(μ H)	Test Freq	RDC(Ω)	Rated Current(A)Max	I _{rms} (A)Typ	Tolerance
SCDS2D18LD-2R2 □ -N	2.2	100KHz, 1V	0.041+0	0.85	2.3	M,T
SCDS2D18LD-3R3 □ -N	3.3	100KHz, 1V	0.054+0	0.75	2.1	M,T
SCDS2D18LD-4R7 □ -N	4.7	100KHz, 1V	0.078+0	0.63	1.65	M,T
SCDS2D18LD-6R8 □ -N	6.8	100KHz, 1V	0.106+0	0.52	1.32	M,T
SCDS2D18LD-100 □ -N	10	100KHz, 1V	0.180+0	0.43	1	M,T
SCDS2D18LD-150 □ -N	15	100KHz, 1V	0.220+0	0.35	0.8	M,T
SCDS2D18LD-220 □ -N	22	100KHz, 1V	0.320+0	0.3	0.68	M,T
SCDS2D18LD-330 □ -N	33	100KHz, 1V	0.460+0	0.24	0.56	M,T
SCDS2D18LD-470 □ -N	47	100KHz, 1V	0.660+0	0.2	0.48	M,T

NOTE : □ -tolerance M=±20% / T=±30%

1. Operating temperature range -40°C~85°C(Includes temperature when the coil is heated)

2. Rate current: Inductance drop = 35% typ.

3. I_{rms}: Δ t=40°C

"-N" FOR COMPLETELY LEAD FREE TYPE(INCLUDING FERRITE BODY & SOLDER)

ELECTRICAL CHARACTERISTICS : LEAD-FREE & ROHS COMPLIANCE

TYPE	Inductance(μ H)	Test Freq	RDC(Ω)	Rated Current(A)Max	I _{rms} (A)Typ	Tolerance
SCDS2D18HP-1R7 □ -N	1.7	100KHz, 1V	0.044+0	1.85	2.2	M,T
SCDS2D18HP-2R2 □ -N	2.2	100KHz, 1V	0.060+0	1.6	1.9	M,T
SCDS2D18HP-3R3 □ -N	3.3	100KHz, 1V	0.086+0	1.45	1.55	M,T
SCDS2D18HP-4R7 □ -N	4.7	100KHz, 1V	0.140+0	1.2	1.2	M,T
SCDS2D18HP-6R3 □ -N	6.3	100KHz, 1V	0.160+0	1.05	1.15	M,T
SCDS2D18HP-100 □ -N	10	100KHz, 1V	0.245+0	0.85	0.9	M,T
SCDS2D18HP-150 □ -N	15	100KHz, 1V	0.345+0	0.7	0.64	M,T

NOTE : □ -tolerance M=±20% / T=±30%

1. Operating temperature range -40°C~85°C(Includes temperature when the coil is heated)

2. Rate current: Inductance drop = 35% typ.

3. I_{rms}: Δ t=40°C

"-N" FOR COMPLETELY LEAD FREE TYPE(INCLUDING FERRITE BODY & SOLDER)



ELECTRICAL CHARACTERISTICS : LEAD-FREE & ROHS COMPLIANCE

TYPE	Inductance(μ H)	Test Freq	RDC(Ω)Max	Rated current(A)Max
SCDS3D12T-1R0 <input type="checkbox"/> -N	1	10KHz,0.1V	0.0401 \pm 30%	1.54
SCDS3D12T-1R5 <input type="checkbox"/> -N	1.5	10KHz,0.1V	0.0635 \pm 30%	1.32
SCDS3D12T-2R2 <input type="checkbox"/> -N	2.2	10KHz,0.1V	0.0835 \pm 30%	1.12
SCDS3D12T-3R3 <input type="checkbox"/> -N	3.3	10KHz,0.1V	0.122 \pm 30%	0.9
SCDS3D12T-4R7 <input type="checkbox"/> -N	4.7	10KHz,0.1V	0.172 \pm 30%	0.72
SCDS3D12T-5R6 <input type="checkbox"/> -N	5.6	10KHz,0.1V	0.191 \pm 30%	0.66
SCDS3D12T-6R8 <input type="checkbox"/> -N	6.8	10KHz,0.1V	0.218 \pm 30%	0.6
SCDS3D12T-8R2 <input type="checkbox"/> -N	8.2	10KHz,0.1V	0.255 \pm 30%	0.57
SCDS3D12T-100 <input type="checkbox"/> -N	10	10KHz,0.1V	0.408 \pm 30%	0.49
SCDS3D12T-120 <input type="checkbox"/> -N	12	10KHz,0.1V	0.462 \pm 30%	0.47
SCDS3D12T-150 <input type="checkbox"/> -N	15	10KHz,0.1V	0.502 \pm 30%	0.41
SCDS3D12T-180 <input type="checkbox"/> -N	18	10KHz,0.1V	0.573 \pm 30%	0.37
SCDS3D12T-220 <input type="checkbox"/> -N	22	10KHz,0.1V	0.801 \pm 30%	0.34
SCDS3D12T-270 <input type="checkbox"/> -N	27	10KHz,0.1V	1.207 \pm 30%	0.3
SCDS3D12T-330 <input type="checkbox"/> -N	33	10KHz,0.1V	1.358 \pm 30%	0.28
SCDS3D12T-390 <input type="checkbox"/> -N	39	10KHz,0.1V	1.911 \pm 30%	0.23

NOTE : -tolerance T= \pm 30%

1.Operating temperature range -40°C~85°C(Includes temperature when the coil is heated)

2.Rate current: The rate current indicates the current when the inductance decreases to 70% over of it's nominal value or D.C.current when the temperature rising Δ T=40°C lower, whichever is lower.

"-N" FOR COMPLETELY LEAD FREE TYPE(INCLUDING FERRITE BODY & SOLDER)



ELECTRICAL CHARACTERISTICS : LEAD-FREE & ROHS COMPLIANCE

TYPE	Inductance(μ H)	Test Freq	RDC(Ω)Max	Rated current(A)Max
SCDS3D16T-1R5 <input type="checkbox"/> -B-N	1.5	100KHz,0.1V	0.052+0	1.55
SCDS3D16T-2R2 <input type="checkbox"/> -B-N	2.2	100KHz,0.1V	0.072+0	1.2
SCDS3D16T-3R3 <input type="checkbox"/> -B-N	3.3	100KHz,0.1V	0.085+0	1.1
SCDS3D16T-4R7 <input type="checkbox"/> -B-N	4.7	100KHz,0.1V	0.105+0	0.9
SCDS3D16T-6R8 <input type="checkbox"/> -B-N	6.8	100KHz,0.1V	0.170+0	0.73
SCDS3D16T-100 <input type="checkbox"/> -B-N	10	100KHz,0.1V	0.210+0	0.55
SCDS3D16T-150 <input type="checkbox"/> -B-N	15	100KHz,0.1V	0.295+0	0.45
SCDS3D16T-220 <input type="checkbox"/> -B-N	22	100KHz,0.1V	0.430+0	0.4
SCDS3D16T-270 <input type="checkbox"/> -B-N	27	100KHz,0.1V	0.620+0	0.62
SCDS3D16T-330 <input type="checkbox"/> -B-N	33	100KHz,0.1V	0.675+0	0.32
SCDS3D16T-470 <input type="checkbox"/> -B-N	47	100KHz,0.1V	1.240+0	0.26

NOTE : -tolerance T= \pm 30%

1.Operating temperature range -40°C~85°C(Includes temperature when the coil is heated)

2.Rate current: The rate current indicates the current when the inductance decreases to 70% over of it's nominal value or D.C.current when the temperature rising Δ T=40°C lower, whichever is lower.

"-N" FOR COMPLETELY LEAD FREE TYPE(INCLUDING FERRITE BODY & SOLDER)



ELECTRICAL CHARACTERISTICS : LEAD-FREE & ROHS COMPLIANCE

TYPE	Inductance(μ H)	Test Freq	RDC(Ω)Max	Rated current(A)Max
SCDS4D28T-1R0 <input type="checkbox"/> -B-N	1	7.96MHz, 1V	0.045+0	1.72
SCDS4D28T-2R2 <input type="checkbox"/> -B-N	2.2	7.96MHz, 1V	0.075+0	1.32
SCDS4D28T-2R7 <input type="checkbox"/> -B-N	2.7	7.96MHz, 1V	0.105+0	1.28
SCDS4D28T-3R3 <input type="checkbox"/> -B-N	3.3	7.96MHz, 1V	0.110+0	1.04
SCDS4D28T-3R9 <input type="checkbox"/> -B-N	3.9	7.96MHz, 1V	0.155+0	0.88
SCDS4D28T-4R7 <input type="checkbox"/> -B-N	4.7	7.96MHz, 1V	0.162+0	0.84
SCDS4D28T-5R6 <input type="checkbox"/> -B-N	5.6	7.96MHz, 1V	0.170+0	0.8
SCDS4D28T-6R8 <input type="checkbox"/> -B-N	6.8	7.96MHz, 1V	0.200+0	0.76
SCDS4D28T-8R2 <input type="checkbox"/> -B-N	8.2	7.96MHz, 1V	0.245+0	0.68
SCDS4D28T-100 <input type="checkbox"/> -B-N	10	7.96MHz, 1V	0.280+0	0.61
SCDS4D28T-120 <input type="checkbox"/> -B-N	12	7.96MHz, 1V	0.320+0	0.56
SCDS4D28T-150 <input type="checkbox"/> -B-N	15	7.96MHz, 1V	0.360+0	0.5
SCDS4D28T-180 <input type="checkbox"/> -B-N	18	7.96MHz, 1V	0.400+0	0.48
SCDS4D28T-220 <input type="checkbox"/> -B-N	22	7.96MHz, 1V	0.480+0	0.41
SCDS4D28T-270 <input type="checkbox"/> -B-N	27	7.96MHz, 1V	0.570+0	0.35
SCDS4D28T-330 <input type="checkbox"/> -B-N	33	7.96MHz, 1V	0.694+0	0.32
SCDS4D28T-390 <input type="checkbox"/> -B-N	39	7.96MHz, 1V	0.800+0	0.3
SCDS4D28T-470 <input type="checkbox"/> -B-N	47	7.96MHz, 1V	0.950+0	0.28
SCDS4D28T-560 <input type="checkbox"/> -B-N	56	7.96MHz, 1V	1.080+0	0.26
SCDS4D28T-680 <input type="checkbox"/> -B-N	68	7.96MHz, 1V	1.300+0	0.24

NOTE : -tolerance T= \pm 30%

1. Operating temperature range -40°C~85°C(Includes temperature when the coil is heated)

2. Rate current: The rate current indicates the current when the inductance decreases to 70% over of it's nominal value or D.C.current when the temperature rising Δ T=40°C lower, whichever is lower.

"-N" FOR COMPLETELY LEAD FREE TYPE(INCLUDING FERRITE BODY & SOLDER)



ELECTRICAL CHARACTERISTICS : LEAD-FREE & ROHS COMPLIANCE

TYPE	Inductance(μ H)	Test Freq	RDC(Ω)Max	Rated current(A)Max
SCDS4D28T-1R2 □ -B-N	1.2	100KHz, IV	0.0236+0	2.56
SCDS4D28T-1R8 □ -B-N	1.8	100KHz, IV	0.0275+0	2.2
SCDS4D28T-2R2 □ -B-N	2.2	100KHz, IV	0.0313+0	2.04
SCDS4D28T-2R7 □ -B-N	2.7	100KHz, IV	0.0433+0	1.6
SCDS4D28T-3R3 □ -B-N	3.3	100KHz, IV	0.0492+0	1.57
SCDS4D28T-3R9 □ -B-N	3.9	100KHz, IV	0.0648+0	1.44
SCDS4D28T-4R7 □ -B-N	4.7	100KHz, IV	0.0720+0	1.32
SCDS4D28T-5R6 □ -B-N	5.6	100KHz, IV	0.1009+0	1.17
SCDS4D28T-6R8 □ -B-N	6.8	100KHz, IV	0.1089+0	1.12
SCDS4D28T-8R2 □ -B-N	8.2	100KHz, IV	0.1175+0	1.04
SCDS4D28T-10 □ -B-N	10	100KHz, IV	0.1283+0	1
SCDS4D28T-120 □ -B-N	12	100KHz, IV	0.1316+0	0.84
SCDS4D28T-150 □ -B-N	15	100KHz, IV	0.1490+0	0.76
SCDS4D28T-180 □ -B-N	18	100KHz, IV	0.1660+0	0.72
SCDS4D28T-220 □ -B-N	22	100KHz, IV	0.2350+0	0.7
SCDS4D28T-270 □ -B-N	27	100KHz, IV	0.2610+0	0.58
SCDS4D28T-330 □ -B-N	33	100KHz, IV	0.3313+0	0.56
SCDS4D28T-390 □ -B-N	39	100KHz, IV	0.3837+0	0.5
SCDS4D28T-470 □ -B-N	47	100KHz, IV	0.5870+0	0.48
SCDS4D28T-560 □ -B-N	56	100KHz, IV	0.6245+0	0.41
SCDS4D28T-680 □ -B-N	68	100KHz, IV	0.6990+0	0.35
SCDS4D28T-820 □ -B-N	82	100KHz, IV	0.9140+0	0.32
SCDS4D28T-101 □ -B-N	100	100KHz, IV	1.0200+0	0.29
SCDS4D28T-121 □ -B-N	120	100KHz, IV	1.2700+0	0.27
SCDS4D28T-151 □ -B-N	150	100KHz, IV	1.3500+0	0.24
SCDS4D28T-181 □ -B-N	180	100KHz, IV	1.5400+0	0.22

NOTE : □ -tolerance T=±30%

1. Operating temperature range -40°C~85°C(Includes temperature when the coil is heated)

2. Rate current: The rate current indicates the current when the inductance decreases to 70% over of it's nominal value or D.C.current when the temperature rising $\Delta T=40^\circ\text{C}$ lower, whichever is lower.

"-N" FOR COMPLETELY LEAD FREE TYPE(INCLUDING FERRITE BODY & SOLDER)



ELECTRICAL CHARACTERISTICS : LEAD-FREE & ROHS COMPLIANCE

TYPE	Inductance(μ H)	Test Freq	RDC(Ω)Max	Rated current(A)Max
SCDS5D18T-2R7 <input type="checkbox"/> -B-N	2.7	10KHz, 1V	0.052+0	2.1
SCDS5D18T-4R1 <input type="checkbox"/> -B-N	4.1	10KHz, 1V	0.057+0	1.95
SCDS5D18T-5R4 <input type="checkbox"/> -B-N	5.4	10KHz, 1V	0.076+0	1.6
SCDS5D18T-6R2 <input type="checkbox"/> -B-N	6.2	10KHz, 1V	0.096+0	1.4
SCDS5D18T-6R8 <input type="checkbox"/> -B-N	6.8	10KHz, 1V	0.100+0	1.35
SCDS5D18T-8R9 <input type="checkbox"/> -B-N	8.9	10KHz, 1V	0.116+0	1.25
SCDS5D18T-100 <input type="checkbox"/> -B-N	10	10KHz, 1V	0.124+0	1.2
SCDS5D18T-120 <input type="checkbox"/> -B-N	12	10KHz, 1V	0.153+0	1.1
SCDS5D18T-150 <input type="checkbox"/> -B-N	15	10KHz, 1V	0.196+0	0.97
SCDS5D18T-180 <input type="checkbox"/> -B-N	18	10KHz, 1V	0.210+0	0.85
SCDS5D18T-220 <input type="checkbox"/> -B-N	22	10KHz, 1V	0.290+0	0.8
SCDS5D18T-270 <input type="checkbox"/> -B-N	27	10KHz, 1V	0.330+0	0.75
SCDS5D18T-330 <input type="checkbox"/> -B-N	33	10KHz, 1V	0.386+0	0.65
SCDS5D18T-390 <input type="checkbox"/> -B-N	39	10KHz, 1V	0.520+0	0.57
SCDS5D18T-470 <input type="checkbox"/> -B-N	47	10KHz, 1V	0.595+0	0.54
SCDS5D18T-560 <input type="checkbox"/> -B-N	56	10KHz, 1V	0.665+0	0.5
SCDS5D18T-680 <input type="checkbox"/> -B-N	68	10KHz, 1V	0.840+0	0.43
SCDS5D18T-820 <input type="checkbox"/> -B-N	82	10KHz, 1V	0.978+0	0.41
SCDS5D18T-101 <input type="checkbox"/> -B-N	100	10KHz, 1V	1.200+0	0.36
SCDS5D18T-121 <input type="checkbox"/> -B-N	120	10KHz, 1V	1.600+0	0.32
SCDS5D18T-151 <input type="checkbox"/> -B-N	150	10KHz, 1V	1.800+0	0.3

NOTE : -tolerance T= \pm 30%

1. Operating temperature range -40°C ~ 85°C (Includes temperature when the coil is heated)

2. Rate current: The rate current indicates the current when the inductance decreases to 70% over of it's nominal value or D.C.current when the temperature rising $\Delta T=40^{\circ}\text{C}$ lower, whichever is lower.

"-N" FOR COMPLETELY LEAD FREE TYPE(INCLUDING FERRITE BODY & SOLDER)



ELECTRICAL CHARACTERISTICS : LEAD-FREE & ROHS COMPLIANCE

TYPE	Inductance(μ H)	Test Freq	RDC(Ω)Max	Rated current(A)Max
SCDS5D28T-2R5 <input type="checkbox"/> -B-N	2.5	10KHz, 1V	0.018+0	2.6
SCDS5D28T-3R0 <input type="checkbox"/> -B-N	3	10KHz, 1V	0.024+0	2.4
SCDS5D28T-4R2 <input type="checkbox"/> -B-N	4.2	10KHz, 1V	0.031+0	2.2
SCDS5D28T-4R7 <input type="checkbox"/> -B-N	4.7	10KHz, 1V	0.038+0	1.9
SCDS5D28T-5R3 <input type="checkbox"/> -B-N	5.3	10KHz, 1V	0.038+0	1.9
SCDS5D28T-6R2 <input type="checkbox"/> -B-N	6.2	10KHz, 1V	0.045+0	1.8
SCDS5D28T-6R8 <input type="checkbox"/> -B-N	6.8	10KHz, 1V	0.050+0	1.65
SCDS5D28T-8R2 <input type="checkbox"/> -B-N	8.2	10KHz, 1V	0.053+0	1.6
SCDS5D28T-100 <input type="checkbox"/> -B-N	10	10KHz, 1V	0.065+0	1.3
SCDS5D28T-120 <input type="checkbox"/> -B-N	12	10KHz, 1V	0.076+0	1.2
SCDS5D28T-150 <input type="checkbox"/> -B-N	15	10KHz, 1V	0.103+0	1.1
SCDS5D28T-180 <input type="checkbox"/> -B-N	18	10KHz, 1V	0.110+0	1
SCDS5D28T-220 <input type="checkbox"/> -B-N	22	10KHz, 1V	0.122+0	0.9
SCDS5D28T-270 <input type="checkbox"/> -B-N	27	10KHz, 1V	0.175+0	0.85
SCDS5D28T-330 <input type="checkbox"/> -B-N	33	10KHz, 1V	0.189+0	0.75
SCDS5D28T-390 <input type="checkbox"/> -B-N	39	10KHz, 1V	0.212+0	0.7
SCDS5D28T-470 <input type="checkbox"/> -B-N	47	10KHz, 1V	0.250+0	0.62
SCDS5D28T-560 <input type="checkbox"/> -B-N	56	10KHz, 1V	0.305+0	0.58
SCDS5D28T-680 <input type="checkbox"/> -B-N	68	10KHz, 1V	0.355+0	0.52
SCDS5D28T-820 <input type="checkbox"/> -B-N	82	10KHz, 1V	0.463+0	0.46
SCDS5D28T-101 <input type="checkbox"/> -B-N	100	10KHz, 1V	0.520+0	0.42

NOTE : -tolerance T= \pm 30%

1. Operating temperature range -40°C~85°C(Includes temperature when the coil is heated)

2. Rate current: The rate current indicates the current when the inductance decreases to 70% over of it's nominal value or D.C.current when the temperature rising Δ T=40°C lower, whichever is lower.

"-N" FOR COMPLETELY LEAD FREE TYPE(INCLUDING FERRITE BODY & SOLDER)



ELECTRICAL CHARACTERISTICS : LEAD-FREE & ROHS COMPLIANCE

TYPE	Inductance(μ H)	Test Freq	RDC(Ω)Max	Rated current(A)Max
SCDS6D28T-3R0 □ -B-N	3	10KHz, 1V	0.024+0	3
SCDS6D28T-3R9 □ -B-N	3.9	10KHz, 1V	0.027+0	2.6
SCDS6D28T-4R7 □ -B-N	4.7	10KHz, 1V	0.031+0	2.4
SCDS6D28T-5R0 □ -B-N	5	10KHz, 1V	0.031+0	2.4
SCDS6D28T-5R6 □ -B-N	5.6	10KHz, 1V	0.035+0	2.25
SCDS6D28T-6R0 □ -B-N	6	10KHz, 1V	0.035+0	2.25
SCDS6D28T-6R8 □ -B-N	6.8	10KHz, 1V	0.052+0	2.1
SCDS6D28T-7R3 □ -B-N	7.3	10KHz, 1V	0.054+0	2.1
SCDS6D28T-8R6 □ -B-N	8.6	10KHz, 1V	0.058+0	1.85
SCDS6D28T-100 □ -B-N	10	10KHz, 1V	0.065+0	1.7
SCDS6D28T-120 □ -B-N	12	10KHz, 1V	0.070+0	1.55
SCDS6D28T-150 □ -B-N	15	10KHz, 1V	0.084+0	1.4
SCDS6D28T-180 □ -B-N	18	10KHz, 1V	0.095+0	1.32
SCDS6D28T-220 □ -B-N	22	10KHz, 1V	0.128+0	1.2
SCDS6D28T-270 □ -B-N	27	10KHz, 1V	0.142+0	1.05
SCDS6D28T-330 □ -B-N	33	10KHz, 1V	0.165+0	0.97
SCDS6D28T-390 □ -B-N	39	10KHz, 1V	0.210+0	0.86
SCDS6D28T-470 □ -B-N	47	10KHz, 1V	0.238+0	0.8
SCDS6D28T-560 □ -B-N	56	10KHz, 1V	0.277+0	0.73
SCDS6D28T-680 □ -B-N	68	10KHz, 1V	0.304+0	0.65
SCDS6D28T-820 □ -B-N	82	10KHz, 1V	0.390+0	0.6
SCDS6D28T-101 □ -B-N	100	10KHz, 1V	0.535+0	0.54

NOTE : □ -tolerance T=±30%

1. Operating temperature range -40°C~85°C(Includes temperature when the coil is heated)

2. Rate current: The rate current indicates the current when the inductance decreases to 70% over of it's nominal value or D.C.current when the temperature rising $\Delta T=40^\circ\text{C}$ lower, whichever is lower.

"-N" FOR COMPLETELY LEAD FREE TYPE(INCLUDING FERRITE BODY & SOLDER)



ELECTRICAL CHARACTERISTICS : LEAD-FREE & ROHS COMPLIANCE

TYPE	Inductance(μ H)	Test Freq	RDC(Ω)Max	Rated current(A)Max
SCDS6D38T-3R3 □ -B-N	3.3	10KHz,0.1V	0.020+0	3.5
SCDS6D38T-4R7 □ -B-N	4.7	10KHz,0.1V	0.022+0	3.1
SCDS6D38T-5R0 □ -B-N	5	10KHz,0.1V	0.024+0	2.9
SCDS6D38T-6R2 □ -B-N	6.2	10KHz,0.1V	0.027+0	2.5
SCDS6D38T-6R8 □ -B-N	6.8	10KHz,0.1V	0.029+0	2.4
SCDS6D38T-7R4 □ -B-N	7.4	10KHz,0.1V	0.031+0	2.3
SCDS6D38T-8R7 □ -B-N	8.7	10KHz,0.1V	0.034+0	2.2
SCDS6D38T-100 □ -B-N	10	10KHz,0.1V	0.038+0	2
SCDS6D38T-120 □ -B-N	12	10KHz,0.1V	0.053+0	1.7
SCDS6D38T-150 □ -B-N	15	10KHz,0.1V	0.057+0	1.6
SCDS6D38T-180 □ -B-N	18	10KHz,0.1V	0.092+0	1.5
SCDS6D38T-220 □ -B-N	22	10KHz,0.1V	0.096+0	1.3
SCDS6D38T-270 □ -B-N	27	10KHz,0.1V	0.109+0	1.2
SCDS6D38T-330 □ -B-N	33	10KHz,0.1V	0.124+0	1.1
SCDS6D38T-390 □ -B-N	39	10KHz,0.1V	0.138+0	1
SCDS6D38T-470 □ -B-N	47	10KHz,0.1V	0.150+0	0.95
SCDS6D38T-560 □ -B-N	56	10KHz,0.1V	0.202+0	0.85
SCDS6D38T-680 □ -B-N	68	10KHz,0.1V	0.234+0	0.75
SCDS6D38T-820 □ -B-N	82	10KHz,0.1V	0.324+0	0.7
SCDS6D38T-101 □ -B-N	100	10KHz,0.1V	0.358+0	0.65

NOTE : □ -tolerance T=±30%

1. Operating temperature range -40°C~85°C(Includes temperature when the coil is heated)

2. Rate current: The rate current indicates the current when the inductance decreases to 70% over of it's nominal value or D.C.current when the temperature rising $\Delta T=40^\circ\text{C}$ lower, whichever is lower.

"-N" FOR COMPLETELY LEAD FREE TYPE(INCLUDING FERRITE BODY & SOLDER)



SCDS SERIES RELIABILITY TEST

I-1 MECHANICAL PERFORMANCE

NO.	ITEM	SPECIFICATION	TEST CONDITIONS
I-1-1	Vibration	Appearance : No Damage L Change : within $\pm 10\%$ Q Change : within $\pm 30\%$ RDC : within Specification	Test device shall be soldered on the substrate. Oscillation Frequency : 10 to 55 to 10Hz for 1Min. Amplitude : 1.5mm Time : 2Hrs. for each Axis (X,Y & Z), Total 6Hrs.
I-1-2	Resistance to Soldering Heat	Appearance : No Damage	Pre-heating : 150°C, 1Min. Solder Composition : Sn/Pb = 63/37 Solder Temperature : 260 \pm 5°C Immersion Time : 10 \pm 1Sec.
I-1-3	Solderability	The electrodes shall be at least 90% covered with new solder coating.	Pre-heating : 150°C, 1Min. Solder Composition : Sn/Pb = 63/37 Solder Temperature : 230 \pm 5°C Immersion Time : 4 \pm 1Sec.

I-2 ENVIRONMENTAL PERFORMANCE

NO.	ITEM	SPECIFICATION	TEST CONDITIONS															
I-2-1	Temperature Shock	Appearance : No Damage L Change : within $\pm 10\%$ L Change : within $\pm 30\%$ RDC : within Specification	10 Cycles (Air to Air) 1 Cycles shall Consist of : 30Min. Exposure to -55°C 30Min. Exposure to -125°C 15Sec. Max. Transition between Temperatures Measured after Exposure in the Room Condition for 24Hrs.															
I-2-2	Temperature Cycle		One Cycle <table border="1" style="margin-left: 20px;"> <thead> <tr> <th>Step</th> <th>Temperature (°C)</th> <th>Time (Min.)</th> </tr> </thead> <tbody> <tr> <td>1</td> <td>-25 \pm 3</td> <td>30</td> </tr> <tr> <td>2</td> <td>25 \pm 2</td> <td>3</td> </tr> <tr> <td>3</td> <td>85 \pm 3</td> <td>30</td> </tr> <tr> <td>4</td> <td>25 \pm 2</td> <td>3</td> </tr> </tbody> </table> Total : 100 Cycles Measured after Exposure in the Room Condition for 24Hrs.	Step	Temperature (°C)	Time (Min.)	1	-25 \pm 3	30	2	25 \pm 2	3	3	85 \pm 3	30	4	25 \pm 2	3
Step	Temperature (°C)	Time (Min.)																
1	-25 \pm 3	30																
2	25 \pm 2	3																
3	85 \pm 3	30																
4	25 \pm 2	3																
I-2-3	Humidity Resistance		Temperature : 40 \pm 2°C Relative Humidity : 90 ~ 95% Time : 1000Hrs. Measured after Exposure in the Room Condition for 24Hrs.															
I-2-4	High Temperature Resistance		Temperature : 85 \pm 3°C Relative Humidity : 20% Applied Current : Rated Current Time : 1000Hrs. Measured after Exposure in the Room Condition for 24Hrs.															
I-2-5	Low Temperature Resistance		Temperature : -25 \pm 3°C Relative Humidity : 0% Time : 1000Hrs. Measured after Exposure in the Room Condition for 24Hrs.															



RECOMMEND SOLDERING CONDITIONS

for: CL/ CLH/ SQV/ SMD power inductors/ SMD Chip Beads/ SMD Filters, Transformers, Current Sensors

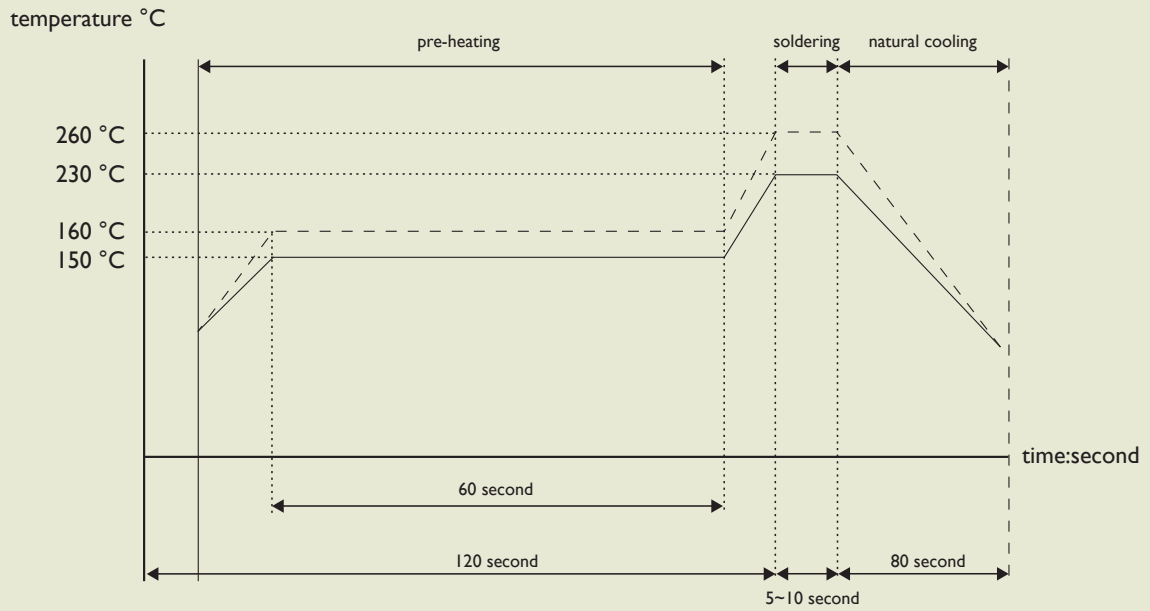

for: lead solder

—————

for: lead-free solder

.....

SMD Shielded Power Inductors

SCDS Series

High Energy Storage & Lower Power Losses

PRODUCT IDENTIFICATION

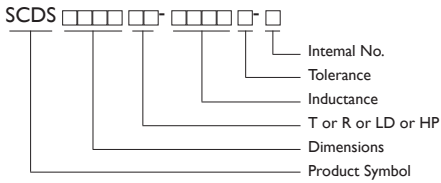

- T :Packaging:Tape and Reel
- R:Core style (Round)
- HP:Low DCR
- LD:High Power
- Tolerance:K=±10%, M=±20%, T=±30%
- Internal No.:B:Silver plated terminals(3D I2~6D38);S:Base type terminals(2D09~2D I8HP&62T~127)
- Note:YAGEO has already released lead-free inductors of SCDS series,and Internal No. will be added a"N" as identification.

RECOMMENDED PATTERN

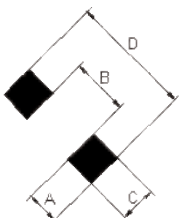

A	B	C	D
1.3	1.7	1.3	4.3

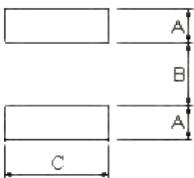

A	B	C
4	3.5	11

APPLICATIONS

- Power supply for VTRs.
- OA equipment.
- LCD televisions.
- Notebook PCs.
- Portable communication equipment.
- DC/DC converters,etc.
- Operating temprayure:-30°C ~100°C (For 2D09/ 4D I8C); -40°C ~85°C (For I014R/ I05R)

FEATURES

- Available in magnetically shielded
- Low DC resistance
- Suitable for large currents.
- Ideal for a variety of DC-DC converter inductor applications.
- Available on tape and reel for auto surface mounting.

SHAPES AND DIMENSIONS

Dimensions : mm

SCDS 2D09

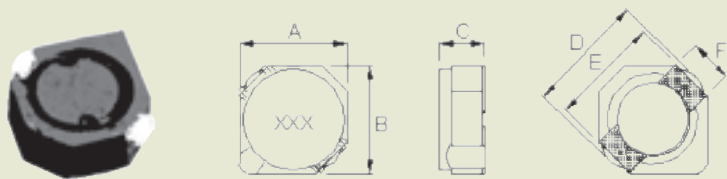

A	B	C	D	E	F
3.2 ⁺⁰	3.2 ⁺⁰	1.0 ⁺⁰	3.3	2.1	1.0

SCDS I014R

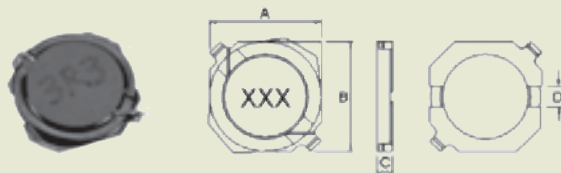

A	B	C	D
10±0.3	10±0.3	1.4±0.3	2.8 TYP



SHAPES AND DIMENSIONS

SCDS 105R

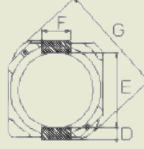
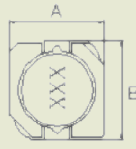

A	B	C	D	E	F	G
10.3 ⁺⁰	10.5 ⁺⁰	5.1 ⁺⁰	1.2	7.7	3.0	13.5 ⁺⁰

RECOMMENDED PATTERN

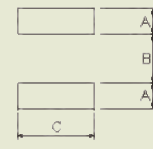

Dimensions : mm

A	B	C
1.6	7.3	3.2

ELECTRICAL CHARACTERISTICS : LEAD-FREE & ROHS COMPLIANCE

TYPE	Inductance(μH)	Test Freq(KHz)	D.C.R(mΩ)Max	Rated Current(A)Max
SCDS2D09T -1R2T-S	1.2	100/IV	97.5	0.80
SCDS2D09T -1R5T-S	1.5	100/IV	110.0	0.73
SCDS2D09T -1R8T-S	1.8	100/IV	131.3	0.65
SCDS2D09T -2R2T-S	2.2	100/IV	143.8	0.60
SCDS2D09T -2R7T-S	2.7	100/IV	150.0	0.53
SCDS2D09T -3R3T-S	3.3	100/IV	193.8	0.47
SCDS2D09T -3R9T-S	3.9	100/IV	225.0	0.45
SCDS2D09T -4R7T-S	4.7	100/IV	287.5	0.41
SCDS2D09T -5R6T-S	5.6	100/IV	325.0	0.37
SCDS2D09T -6R8T-S	6.8	100/IV	425.0	0.33
SCDS2D09T -8R2T-S	8.2	100/IV	475.0	0.30
SCDS2D09T -100T-S	10	100/IV	537.5	0.28

- Inductance range 1.2uH to 10uH
- Tolerance : T=±30%
- Rated current: The rate current indicates the current when the inductance decreases to 65% over of it's nominal value or D.C.current when the temperature rising $\Delta t = 40^{\circ}\text{C}$ lower, whichever is lower.
- Test instrument : L : hp4284A ; RDC : CHEN HWA 502BC ; Rated current : HP4284+42842A or CH1061+CH301A

ELECTRICAL CHARACTERISTICS : LEAD-FREE & ROHS COMPLIANCE

TYPE	Inductance(μH)	Test Freq	RDC(Ω)	Rated Current(A)Max	Irms(A)Typ	Tolerance
SCDS2D09T -1R2 <input type="checkbox"/> -N	1.2	100KHz/IV	0.0975+0	0.8	1.24	T
SCDS2D09T -1R5 <input type="checkbox"/> -N	1.5	100KHz/IV	0.1100+0	0.73	1.15	T
SCDS2D09T -1R8 <input type="checkbox"/> -N	1.8	100KHz/IV	0.1313+0	0.65	1.06	T
SCDS2D09T -2R2 <input type="checkbox"/> -N	2.2	100KHz/IV	0.1438+0	0.6	1.05	T
SCDS2D09T -2R7 <input type="checkbox"/> -N	2.7	100KHz/IV	0.1500+0	0.53	0.98	T
SCDS2D09T -3R3 <input type="checkbox"/> -N	3.3	100KHz/IV	0.1938+0	0.47	0.84	T
SCDS2D09T -3R9 <input type="checkbox"/> -N	3.9	100KHz/IV	0.2250+0	0.45	0.72	T
SCDS2D09T -4R7 <input type="checkbox"/> -N	4.7	100KHz/IV	0.2875+0	0.41	0.64	T
SCDS2D09T -5R6 <input type="checkbox"/> -N	5.6	100KHz/IV	0.3250+0	0.37	0.59	T
SCDS2D09T -6R8 <input type="checkbox"/> -N	6.8	100KHz/IV	0.4250+0	0.33	0.53	T
SCDS2D09T -8R2 <input type="checkbox"/> -N	8.2	100KHz/IV	0.4750+0	0.3	0.46	T
SCDS2D09T -100 <input type="checkbox"/> -N	10	100KHz/IV	0.5375+0	0.28	0.42	M,T
SCDS2D09T -220 <input type="checkbox"/> -N	22	100KHz/IV	1.5000+0	0.2	-	M,T

NOTE : -tolerance M=±20% / T=±30%1. Operating temperature range $-40^{\circ}\text{C} \sim 85^{\circ}\text{C}$ (Includes temperature when the coil is heated)

2. Rate current: Inductance drop = 35% typ.

3. Irms: $\Delta t = 40^{\circ}\text{C}$

"-N" FOR COMPLETELY LEAD FREE TYPE (INCLUDING FERRITE BODY & SOLDER)



ELECTRICAL CHARACTERISTICS : LEAD-FREE & ROHS COMPLIANCE

TYPE	Inductance(μ H)	Test Freq(KHz)	D.C.R(m Ω)Max	Rated Current(A)Max
SCDSI014R-100M -S	10	100/1V	0.17	1.8
SCDSI014R-150M -S	15	100/1V	0.24	1.4
SCDSI014R-220M -S	22	100/1V	0.33	1.2
SCDSI014R-330M -S	33	100/1V	0.50	0.9

- Inductance range 10uH to 33uH
- Tolerance : M= \pm 20%
- 2.Rate current: Inductance drop = 35% typ.
- Test instrument : L :hp192A or HP4263B. RDC : CHEN HWA 502BC Rated current : CH1061+301A

ELECTRICAL CHARACTERISTICS : LEAD-FREE & ROHS COMPLIANCE

TYPE	Inductance(μ H)	Test Freq(KHz)	D.C.R(m Ω)Max	Rated Current(A)Max
SCDSI05R -R80T-S	0.8	100/1V	4.3	9.50
SCDSI05R -1R5T-S	1.5	100/1V	5.8	8.30
SCDSI05R -2R2T-S	2.2	100/1V	7.2	7.50
SCDSI05R -3R3T-S	3.3	100/1V	10.4	6.50
SCDSI05R -4R7T-S	4.7	100/1V	12.3	6.10
SCDSI05R -6R8T-S	6.8	100/1V	18	5.40
SCDSI05R -8R2T-S	8.2	100/1V	20	5.00
SCDSI05R -100T-S	10	100/1V	26	4.50
SCDSI05R -120T-S	12	100/1V	33	3.80
SCDSI05R -150T-S	15	100/1V	41	3.40
SCDSI05R -180T-S	18	100/1V	46	3.10
SCDSI05R -220T-S	22	100/1V	61	2.90
SCDSI05R -270T-S	27	100/1V	69	2.60
SCDSI05R -330T-S	33	100/1V	84	2.50
SCDSI05R -390T-S	39	100/1V	106	2.25
SCDSI05R -470T-S	47	100/1V	130	2.00
SCDSI05R -560T-S	56	100/1V	149	1.90
SCDSI05R -680T-S	68	100/1V	201	1.60
SCDSI05R -820T-S	82	100/1V	227	1.45
SCDSI05R -101T-S	100	100/1V	253	1.35
SCDSI05R -121T-S	120	100/1V	303	1.18
SCDSI05R -151T-S	150	100/1V	370	1.10
SCDSI05R -181T-S	180	100/1V	419	1.00
SCDSI05R -221T-S	220	100/1V	500	0.94
SCDSI05R -271T-S	270	100/1V	672	0.80
SCDSI05R -331T-S	330	100/1V	812	0.73
SCDSI05R -391T-S	390	100/1V	953	0.70
SCDSI05R -471T-S	470	100/1V	1289	0.54
SCDSI05R -561T-S	560	100/1V	1430	0.52
SCDSI05R -681T-S	680	100/1V	1599	0.51
SCDSI05R -821T-S	820	100/1V	1768	0.48
SCDSI05R -102T-S	1000	100/1V	1989	0.42

- Inductance range 0.8uH to 10000uH
- Tolerance : T= \pm 30%
- 2.Rate current: Inductance drop = 10% typ.
- Test instrument : L :hp192A or HP4263B; RDC : CHEN HWA 502BC ; Rated current : HP4284+42842A



PACKAGING SPECIFICATIONS

Tape Dimensions

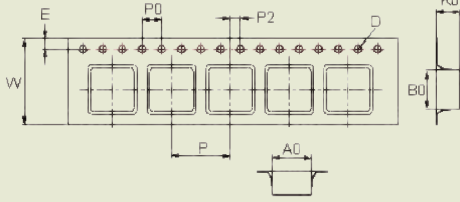

Tape Material

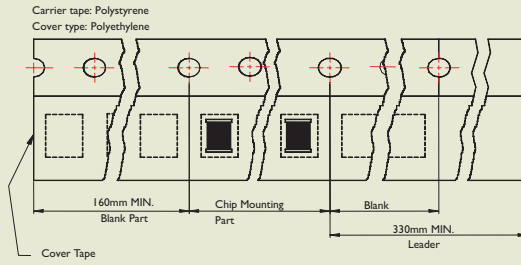

Reel Dimensions

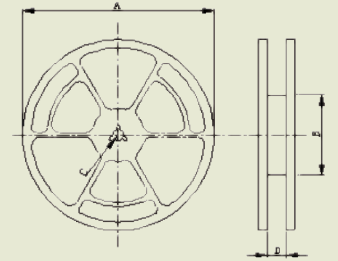

TYPE	TAPE DIMENSIONS									REEL DIMENSIONS				QUANTITY
	A0	B0	K0	D	E	E	P	P0	P2	A	B	C	D	PCS/REEL
SCDS 1014R	10.5	10.5	1.9	1.5	1.75	24	16	4	2	330	100	13	24.4	1000
SCDS 105R	10.5	10.5	5.1	1.5	1.75	24	16	4	2	330	100	13	24.4	500
SCDS 2D09	3.3	3.3	1.3	1.5	1.75	12	8	4	2	178	60	13	13.2	1500

RECOMMEND SOLDERING CONDITIONS

for: CL/ CLH/ SQV/ SMD power inductors/ SMD Chip Beads/ SMD Filters, Transformers, Current Sensors

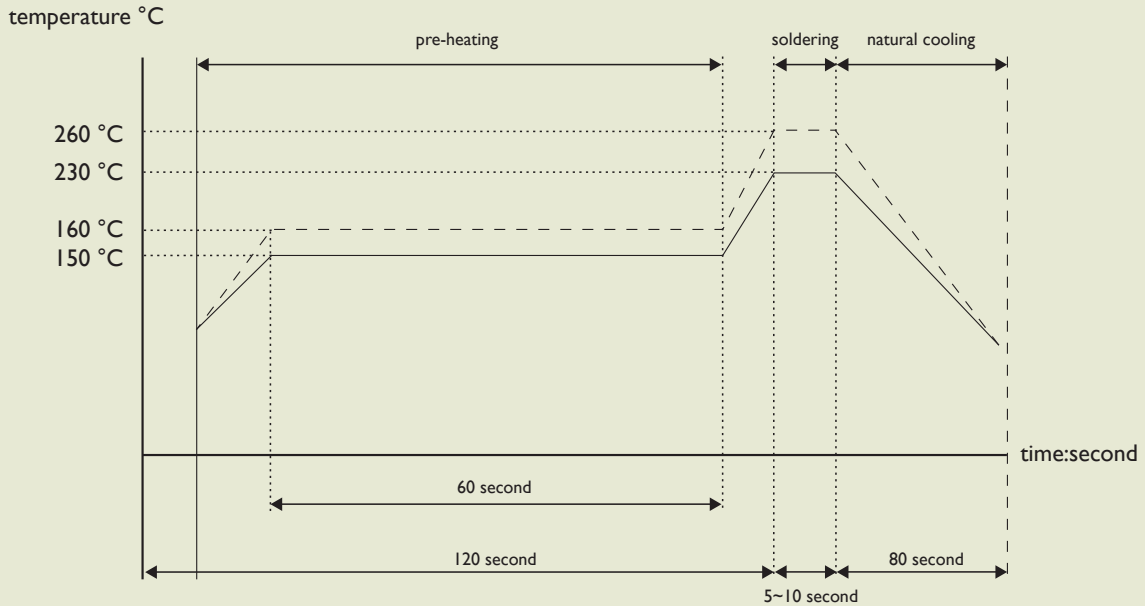

for: lead solder ————

for: lead-free solder ······